

 www.atmegymed.com



A Partner you Trust

ATM
Egyptian Italian Co.



Egyptian Italian Co.

Head office address: 2nd Round, Elfardoas Towers,
the organization square, Shubra Elkhima,
Qalyubia, Egypt
Tel. : +202 440 69 983
Mob.: +20 112 22 70222
E-Mail: m.magdy@atmegymed.com



Product Catalog

Egyptian Italian Co. has started production and sale of disposable surgical gowns, surgical drape sets, medical dressing and medical Gauze with brand in its own facilities in the beginning of 2007 to convey its experiment, in non-woven sector since 2004, to medical sector.

Egyptian Italian Co., having a well-earned place in all over Egypt with brand by quick delivering all kinds of consumable goods, mostly gauze, nonwoven and gloves, which have been produced and as well imported since its establishment, 2007, has hold a prominent place and been an important brand, especially in the markets of Africa, Middle East and Europe with its export activities.

Egyptian Italian Co., making use of ever developing technologies since the Beginning of 2010, improved its all-machine lines and sterilization devices, and extended its production and stock areas to a total 11.000 SM closed area.

Egyptian Italian Co. is steadily carrying on its activities to hold the prominence to be one of the leading brands in the medical sector with high quality and fair price it has been offering in the market with brand.

Vision:

- To become a leading player in the global medical device industry.

Mission:

- Egyptian Italian Co. aims to be a reference for all companies seeking a reliable partner in the development and production of medical devices.
- Our main investments have always been focused on technological innovation of products and professional growth of our collaborators.
- Integration of know-how and experience within a modern and flexible organization guarantees an adequate solution to each need and requirement.
- The mission of our organization is to offer tailor-made solutions aimed at full satisfaction of our customers.

Quality Policy:

- To make production in the medical sector with the latest technology and provide persistence in production quality and a quality management system.
- To enhance the customer satisfaction by taking any suggestions and complaints into consideration.
- To offer products and services in compliance with current laws and regulations by giving due importance to human health.

Control:

- Documented quality control system in all production phase:
 - Incoming inspection.
 - In-process inspection.
 - Final inspection.
- Quality control plans
- Visual, dimensional, functional, microbial and technical test on products.
- Technical advanced test equipment.

Certificates:

CE2265, ISO 13485, ISO 9001



Description	QTY	Size
Extremity Drape Heavy Reinforced Elastic Fenestration 3-cm & tube holder	1	160*240
Self Adhesive Drape	1	80*100
Trolley (Back Table Cover)	1	150*190
U Split drape	1	160*300
Mayo Stand Cover	1	80*145
Double Face Tape	2	10*50
Medical Towels	4	30*33
Stockinette	1	45*110

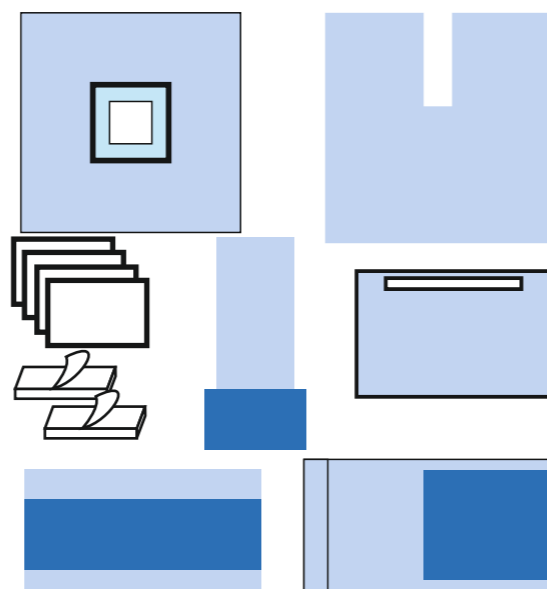

Product Use	General Orthopedic - 01
Product Code	DU01

Description	QTY	Size
U Split Sheet Heavy Reinforced Split with (10*50) cm	1	150*180
Self-adhesive drape	1	80*100
Trolley (Back Table Cover)	1	150*190
U Split Drape with (10*50) cm	1	150*180
Mayo Stand Cover	1	80*145
Double Face Tape	2	10*50
Medical Towels	4	30*33
Stockinette	1	45*110

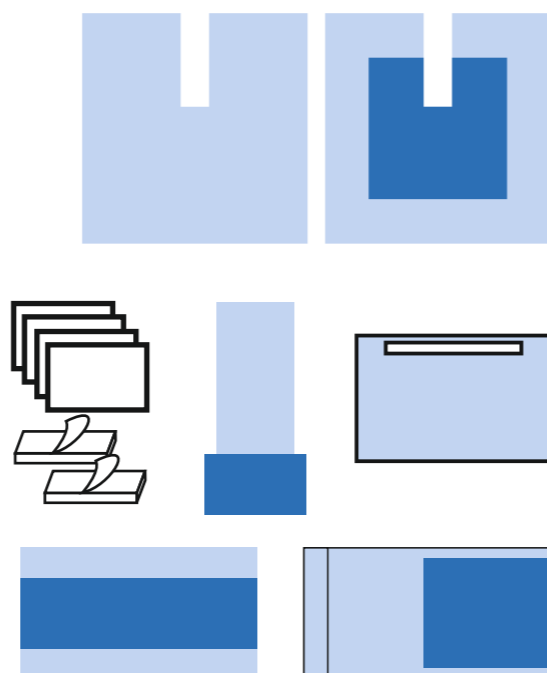

Product Use	General Orthopedic - 02
Product Code	DU01

Alcohol Swabs		
Product size	Packing Type	Pieces Box
Standard Size	100 pcs / Box	15000 pcs



Surgical Dressing Pad		
Product size	Packing Type	Pieces Box
6 cm x 8 cm	85 pcs / Box	1300 pcs
10 cm x 12 cm	25 pcs / Box	500 pcs
10 cm x 18 cm	25 pcs / Box	450 pcs
10 cm x 25 cm	25 pcs / Box	450 pcs
10 cm x 35 cm	25 pcs / Box	450 pcs



SMS Sheets		
Product size	Packing Type	Pieces Box
50 cm x 50 cm	Plastic Bag	250 Sheets
60 cm x 60 cm	Plastic Bag	250 Sheets
75 cm x 75 cm	Plastic Bag	250 Sheets
90 cm x 90 cm	Plastic Bag	250 Sheets
100 cm x 100 cm	Plastic Bag	250 Sheets
120 cm x 120 cm	Plastic Bag	250 Sheets



Cotton Gauze		
Product size	Packing Type	Pieces Box
90 cm x 50 m	Plastic Bag	10 pcs



Medical Cotton		
Product size	Packing Type	Pieces Box
1000 gm	10 pcs / Plastic Bag	10 kg
500 gm	20 pcs / Plastic Bag	10 kg
250 gm	40 pcs / Plastic Bag	10 kg
100 gm	100 pcs / Plastic Bag	10 kg
50 gm	200 pcs / Plastic Bag	10 kg



I.V Cannula		
Product size	Packing Type	Pieces Box
Standard Size	100 pcs / Box	2000 pcs



Eye Patch		
Product size	Packing Type	Pieces Box
Standard Size	50 pcs / Box	3000 pcs



Creep Sheets		
Product size	Packing Type	Pieces Box
50 cm x 50 cm	Plastic Bag	250 Sheets
60 cm x 60 cm	Plastic Bag	250 Sheets
75 cm x 75 cm	Plastic Bag	250 Sheets
100 cm x 100 cm	Plastic Bag	250 Sheets
120 cm x 120 cm	Plastic Bag	250 Sheets



Description	QTY	Size
U Split Sheet Heavy Reinforced Split with (10*50) cm	1	160*200
Head drape	1	130*180
Trolley(Back Table Cover)	1	150*190
Foot drape	1	80*100
Mayo Stand Cover	1	80*145
Double Face Tape	2	10*50
Medical Towels	4	30*33
Stockinette	1	45*110

Product Use	Hip - 01
Product Code	DU02

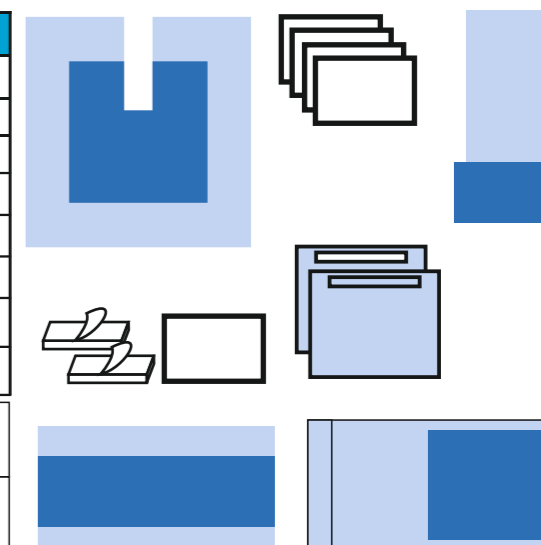

Description	QTY	Size
U Split Sheet Heavy Reinforced Split with (10*50) cm	1	160*200
Head drape	1	130*180
Trolley(Back Table Cover)	1	150*190
Foot drape	1	80*100
Mayo Stand Cover	1	80*145
Double Face Tape	2	10*50
Medical Towels	4	30*33
Stockinette	1	45*110

Product Use	Hip - 02
Product Code	DU02



Description	QTY	Size
Drape With Opening (Craniotomy Drape, With Reinforced Area)	1	188/297*343
Trolley (Back Table Cover)	1	150*190
Mayo Stand Cover	1	80*145
Self Adhesive Drape	4	80*100
Double Face Tape	1	10*50
Medical Towels	2	30*33

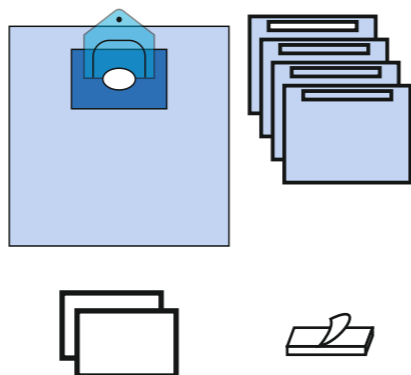

Product Use	Neuro - 01
Product Code	DL01

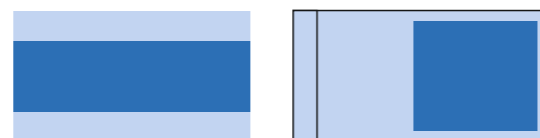

Description	QTY	Size
Drape With Opening	1	160*300
Trolley (Back Table Cover)	1	150*190
Mayo Stand Cover	1	80*145
Double Face Tape	1	10*50
Medical Towels	2	30*33

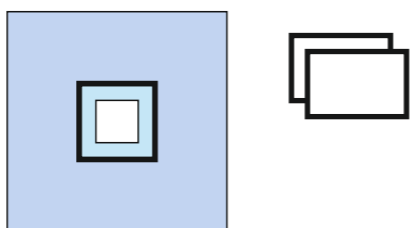

Product Use	Neuro - 02
Product Code	DL01

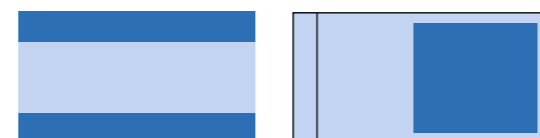

Description	QTY	Size
Drape with Opening (20*28) with Pouch	1	
Trolley (Back Table Cover)	1	150*190
Mayo Stand Cover	1	80*145
Self Adhesive Drape	4	80*100

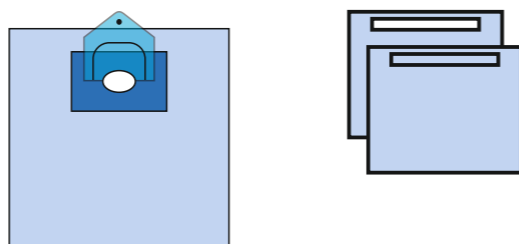

Product Use	Neuro - 02
Product Code	DL01

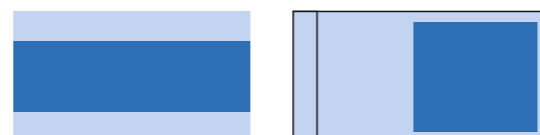

Face Mask		
Product size	Packing Type	Pieces Box
Standard Size	50 pcs / Box	2000 pcs



Safety Box (Carton)		
Product size	Packing Type	Pieces Box
3 Litter	Rope Strap	25 pcs
6 Litter	Rope Strap	25 pcs
10 Litter	Rope Strap	25 pcs
12 Litter	Rope Strap	25 pcs



Dressing Pad		
Product size	Packing Type	Pieces Box
10cm x 10cm	40 pcs / Box	1080 pcs
10cm x 20cm	25 pcs / Box	600 pcs
10cm x 25cm	17 pcs / Box	425 pcs



Plaster of Paris Bandage		
Product size	Packing Type	Pieces Box
7.5 cm x 2.7 m	12 pcs / Plastic Bag	240 pcs
10 cm x 2.7 m	12 pcs / Plastic Bag	120 pcs
15 cm x 2.7 m	12 pcs / Plastic Bag	120 pcs
20 cm x 2.7 m	12 pcs / Plastic Bag	60 pcs



Crepe Bandage

Product size	Packing Type	Pieces Box
6 cm x 1.5 m	Carton	350 pcs
8 cm x 1.5 m	Carton	275 pcs
10 cm x 1.5 m	Carton	250 pcs
12 cm x 1.5 m	Carton	220 pcs
15 cm x 1.5 m	Carton	150 pcs



Non-woven Bandage

Product size	Packing Type	Pieces Box
5 cm x 2 m	50 pcs / Plastic Bag	1500 pcs
7 cm x 2 m	50 pcs / Plastic Bag	1000 pcs
10 cm x 2 m	50 pcs / Plastic Bag	750 pcs
15 cm x 2 m	50 pcs / Plastic Bag	500 pcs



Orthopedic Bandage

Product size	Packing Type	Pieces Box
7.5 cm x 2.7 m	12 pcs / Plastic Bag	240 pcs
10 cm x 2.7 m	12 pcs / Plastic Bag	216 pcs
15 cm x 2.7 m	12 pcs / Plastic Bag	144 pcs
20 cm x 2.7 m	12 pcs / Plastic Bag	96 pcs



Vaseline Gauze

Product size	Packing Type	Pieces Box
10cm x 10cm	50 pcs / Box	1400 pcs
10cm x 20cm	50 pcs / Box	850 pcs
10cm x 30cm	25 pcs / Box	850 pcs



Description	QTY	Size
Arthroscopy Drape Elastic Fenestration with Flu	1	160*240
Self Adhesive Drape	1	80*100
Trolley (Back Table Cover)	1	150*190
Mayo Stand Cover	1	80*145
Double Face Tape	2	10*50
Medical Towel	4	30*33
Stockinette	1	45*110

Product Use	Shoulder - 04
Product Code	DU01

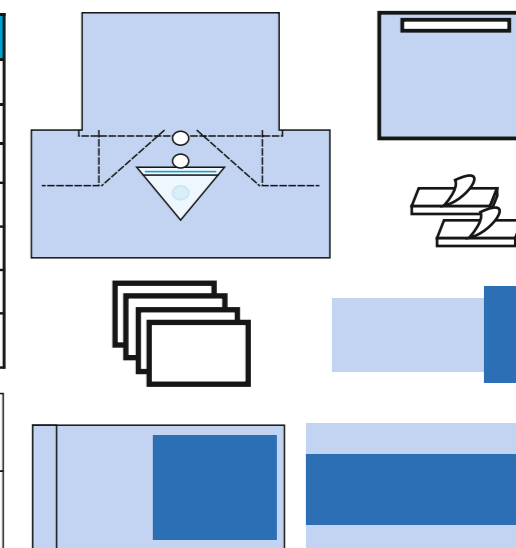

Description	QTY	Size
U Split Sheet Heavy Reinforced Split with (10*50) cm	1	220*250
Trolley (Back Table Cover)	1	150*190
Mayo Stand Cover	1	80*145
Double Face Tape	2	10*50
Medical Towel	4	30*33
Stockinette	1	25*80
Self Adhesive Drape	1	160*240
Plain Drape	1	160*180

Product Use	Shoulder - 05
Product Code	DU01

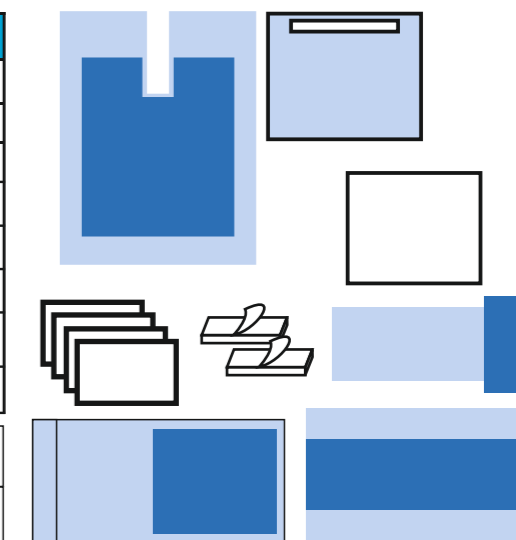

Description	QTY	Size
U Split Sheet Heavy Reinforced Split with (10*50) cm	1	220*260
Trolley (Back Table Cover)	1	150*190
Mayo Stand Cover	1	80*145
Double Face Tape	2	10*50
Medical Towels	4	30*33
Stockinette	1	45*110
Self Adhesive Drape	1	150*240

Product Use	Shoulder - 01
Product Code	DU02

Description	QTY	Size
Split Sheet Heavy Reinforced	1	160*240
Self Adhesive Drape	1	180*160
Trolley(Back Table Cover)	1	150*190
Mayo Stand Cover	1	80*145
Double Face Tape	2	10*50
Medical Towels	4	30*33
Stockinette	1	45*110

Product Use	Shoulder - 02
Product Code	DU01

Description	QTY	Size
Split Sheet Heavy Reinforced	1	160*240
Self Adhesive Drape	1	180*160
Trolley(Back Table Cover)	1	150*190
Mayo Stand Cover	1	80*145
Double Face Tape	2	10*50
Self Adhesive Drape	2	80*90
Foot drape	1	80*100
PE-Bag	1	30*40
Double Face Tape	2	10*50
Medical Towels	4	30*33
Stockinette	1	110*45

Product Use	Shoulder - 03
Product Code	DU01

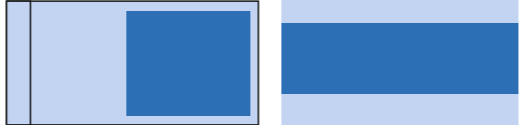
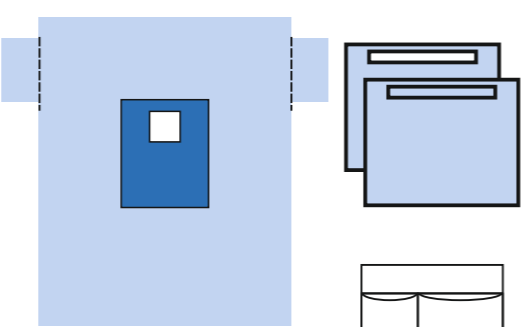
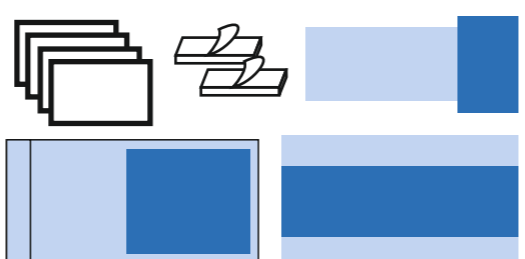
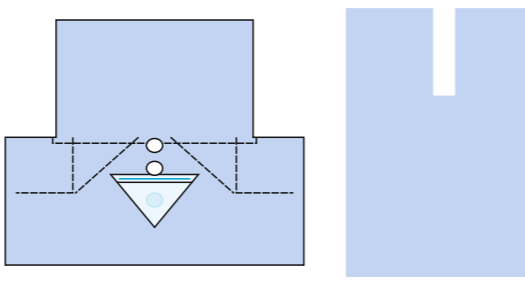
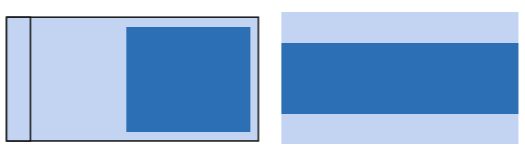
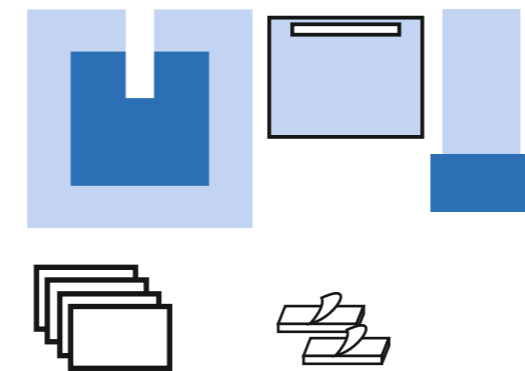

Sterilization Roll		
Product size	Packing Type	Pieces Box
5 cm x 200 m	Carton	8 pcs
7.5 cm x 200 m	Carton	4 pcs
10 cm x 200 m	Carton	4 pcs
15 cm x 200 m	Carton	2 pcs
20 cm x 200 m	Carton	2 pcs
25 cm x 200 m	Carton	1 pcs
30 cm x 200 m	Carton	1 pcs
35 cm x 200 m	Carton	1 pcs
40 cm x 200 m	Carton	1 pcs
5 cm x 100 m	Carton	8 pcs
7.5 cm x 100 m	Carton	4 pcs
10 cm x 100 m	Carton	4 pcs
15 cm x 100 m	Carton	2 pcs
20 cm x 100 m	Carton	2 pcs
25 cm x 100 m	Carton	1 pcs
30 cm x 100 m	Carton	1 pcs
35 cm x 100 m	Carton	1 pcs
40 cm x 100 m	Carton	1 pcs



1-Standard Surgical Gown

Product Code	
S	GS01
M	GS02
XL	GS03
3XL	GS04



Description	QTY	Size
U Split Sheet Heavy Reinforced Split with (10*50) cm	1	150*180
Trolley(Back Table Cover)	1	150*190
Mayo Stand Cover	1	80*145
Double Face Tape	2	10*50
Medical Towels	4	30*33
Stockinette	1	45*110
Self Adhesive Drape	1	80*90
Extremity Drape Open Size 6cm	1	220*320

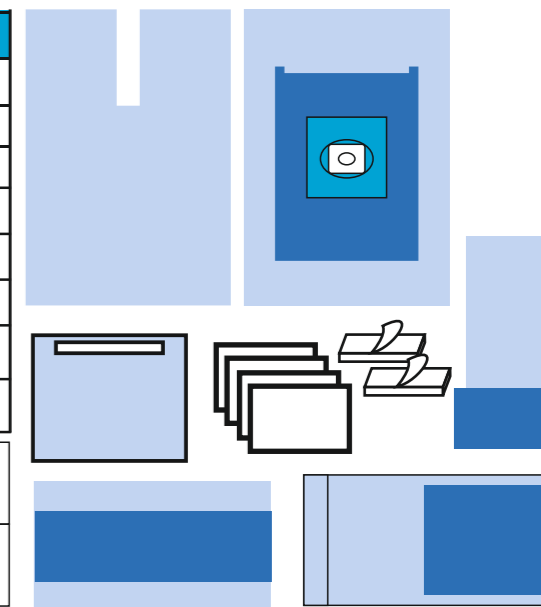

Product Use	Knee - 01
Product Code	DU02

2-Reinforced Surgical Gown

Product Code	
S	GS01
M	GS02
XL	GS03
3XL	GS04



Description	QTY	Size
Splice Drape With Heavy Reinforced (25*30)	1	150*300
Trolley (Back Table Cover)	1	150*300
Mayo Stand Cover	1	80*145
Self Adhesive Drape	4	80*90

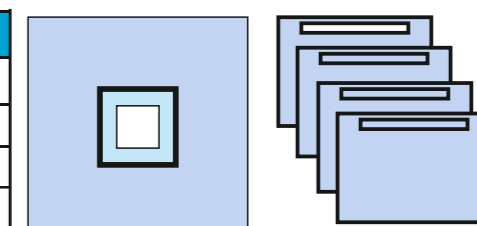

Product Use	Back Bone - 01
Product Code	DU01

3-Full Reinforced Surgical Gown

Product Code	
S	GS01
M	GS02
XL	GS03
3XL	GS04

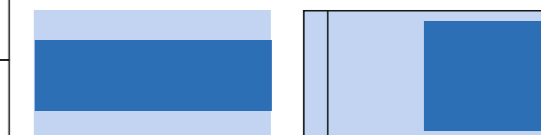

Description	QTY	Size
Drape With Opening(Angiography Drape)	1	150*250
Trolley (Back Table Cover)	1	150*190
Self-Adhesive Drape	1	80*100
C-Arm cover	1	40*40
Medical Towels	1	30*33

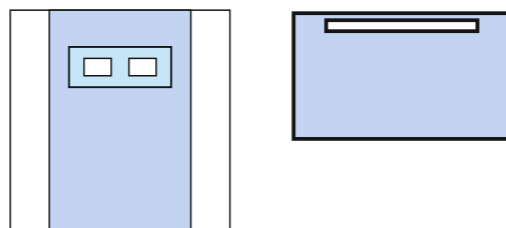

Product Use	Cardio - 04
Product Code	DL01

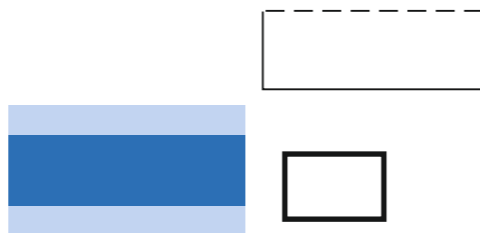

Product Use	C.V.P Drape
Product Code	DL01
Size	75*80

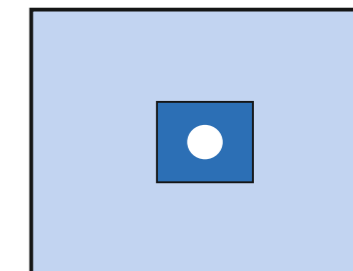

Product Use	Trolley (Back Table COver)
Product Code	DP04
Size	150*190



Description	QTY	Size
Drape With Opening(Angiography Drape)	1	150*250
Trolley (Back Table Cover)	1	150*190
Self-Adhesive Drape	1	80*100
C-Arm cover	1	40*40
Medical Towels	1	30*33

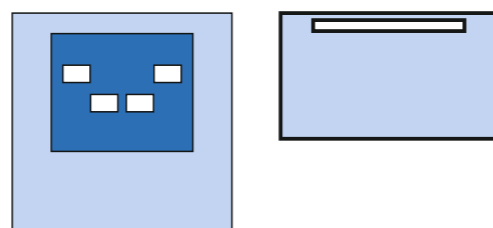

Product Use	Cardio - 05
Product Code	DL01

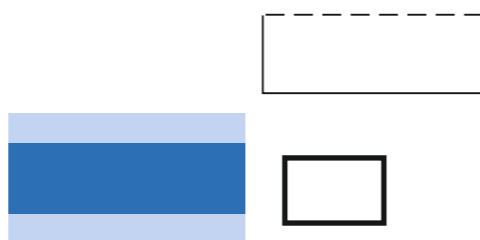

Product Use	Self Adhesive Drape
Product Code	DP03
Size	80*100

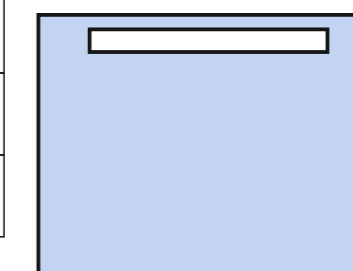

Product Use	Leggings
Product Code	DP04
Size	100*160

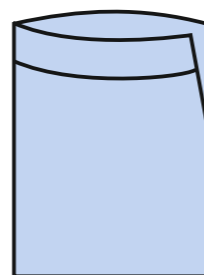

Product Use	Plan Drape Non Adhesive
Product Code	DP04
Size	150*180



Description	QTY	Size
Drape With Opening	1	240*320
Trolley (Back Table Cover)	1	150*190
Mayo Stand Cover	1	80*145
Double Face Tape	2	10*50
Medical Towels	4	30*33
Self Adhesive Drape	2	80*100
U -Drape Sheet	1	160*300
Over Shoes Cover	2	16*42

Product Use	Cardio - 01
Product Code	DL01

Description	QTY	Size
Chest Drape-High Absorbent	1	240*320
Trolley (Back Table Cover)	1	150*190
Mayo Stand Cover	1	80*145
Double Face Tape	2	10*50
Medical Towels	4	30*33
Self Adhesive Drape	4	80*100
U Split Sheet Heavy Reinforced Split with (10*50) cm	1	160*300
Over Shoes Cover	2	16*42
PE Bag	1	30*40

Product Use	Cardio - 02
Product Code	DL01

Description	QTY	Size
Drape With Opening (Chest Drape)	1	240*320
Trolley (Back Table Cover)	1	150*190
Mayo Stand Cover	1	80*145
Double Face Tape	1	10*50
Medical Towels	2	30*33

Product Use	Cardio - 03
Product Code	DL01

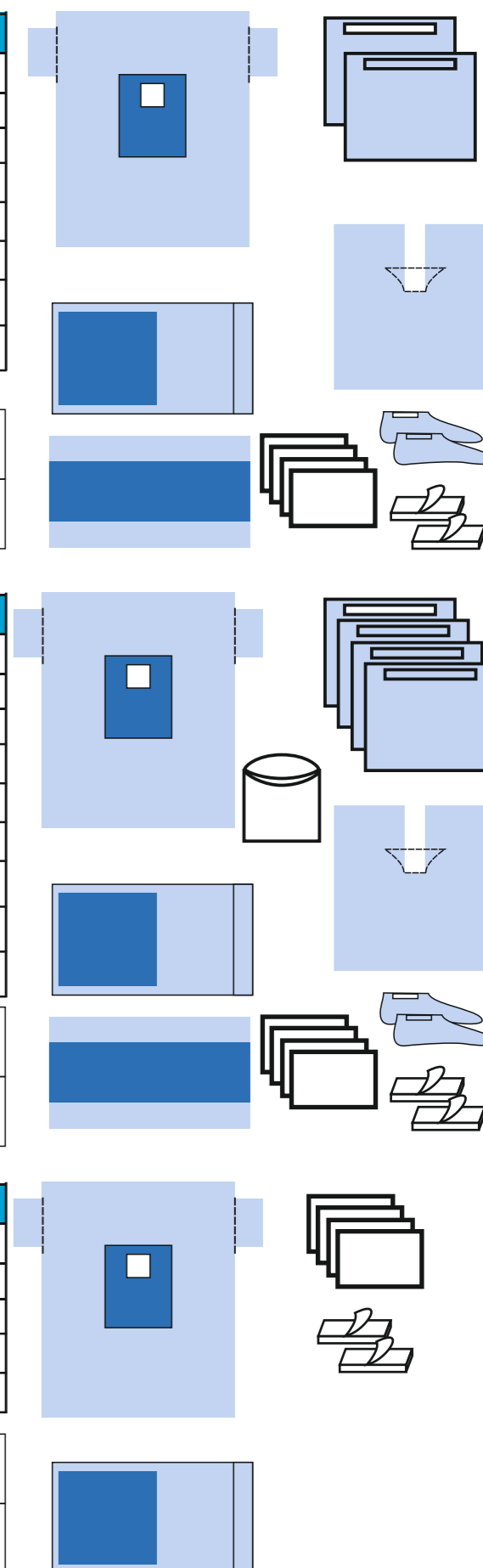

Description	QTY	Size
Self Adhesive Drape	1	80*100
Trolley (Back Table Cover)	1	150*190
Leggings	2	80*145
Medical Towel	2	30*33

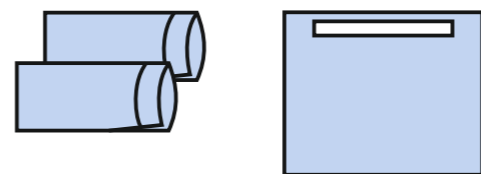

Product Use	Urology - 01
Product Code	DL01



Description	QTY	Size
Trolley (Back Table Cover)	1	150*190
Drape With Opening (6*8) (T.U.R Drape)	1	280*275/242
Double Face Tape	1	10*50
Medical Towel	2	30*33

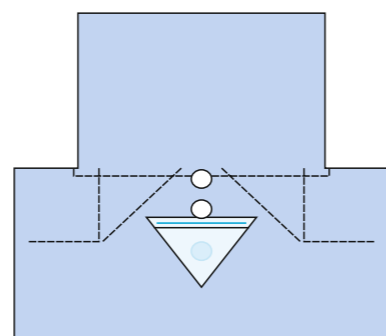

Product Use	Urology - 02
Product Code	DL01



Description	QTY	Size
Trolley (Back Table Cover)	1	150*190
Drape With Opening (6*8) (T.U.R Drape)	1	280*275/242

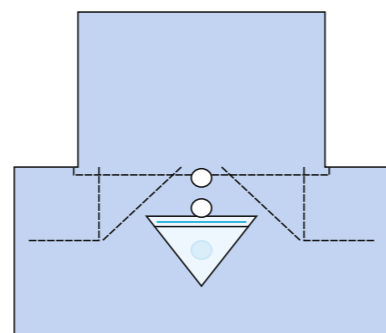

Product Use	Urology - 03
Product Code	DL01



Product Use	Plain Ophthalmic Drape - 01
Product Code	D001
Size	50*50

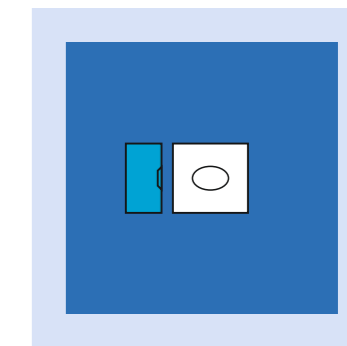

Product Use	Plain Ophthalmic Drape - 02
Product Code	D001
Size	75*80

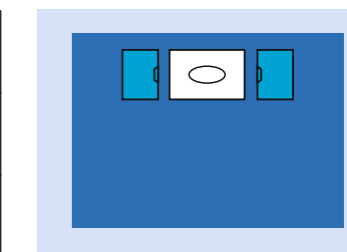

Product Use	Plain Ophthalmic Drape - 03
Product Code	D001
Size	150*100

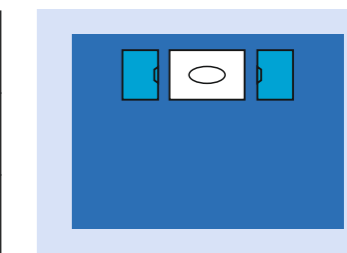

Description	QTY	Size
Ophthalmic drape with two pouches open size 10 CM	1	120*150
Trolley (Back Table cover)	2	100*100
PE Bag	2	30*40
Surgical Gown	2	XL
Double Face Tape	2	50*10
Medical Towels	2	30*33

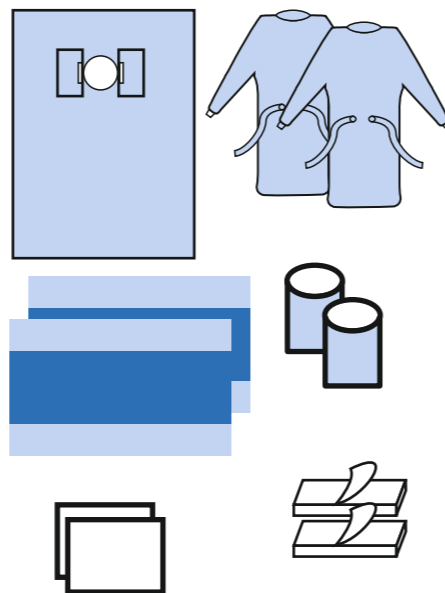

Product Use	Ophthalmic - 01
Product Code	D002

Description	QTY	Size
Ophthalmic drape with two pouches open size 10 CM	1	120*150
Trolley(Back Table Cover)	1	150*190
Medical Towels	2	30*33

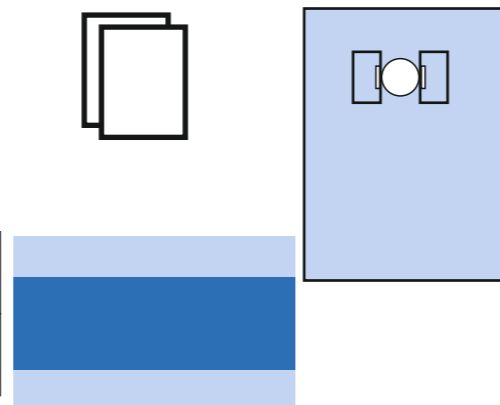

Product Use	Ophthalmic - 02
Product Code	D002

Description	QTY	Size
Laparotomy Drape With Opening	1	160*300
Trolley (Back Table Cover)	1	150*190
Double Face Tape	2	10*50
Medical Towels	4	30*33
PE Bag	1	30*40

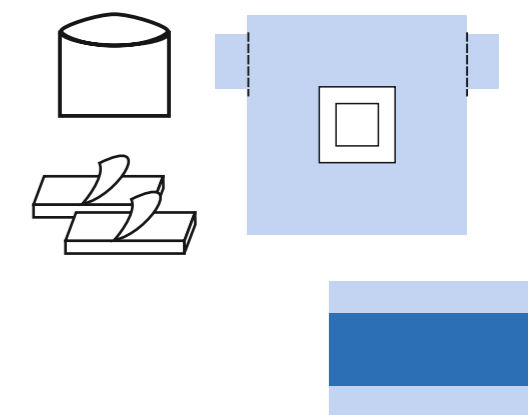

Product Use	General Surgical - 01
Product Code	DL01

Description	QTY	Size
Drape With Reinforced Area	1	160*300
Self Adhesive Drape	1	80*100
Trolley (Back Table Cover)	1	150*190
Mayo Stand Cover	1	80*145
Double Face Tape	2	10*50
Medical Towels	4	30*33
PE Bag	1	30*40

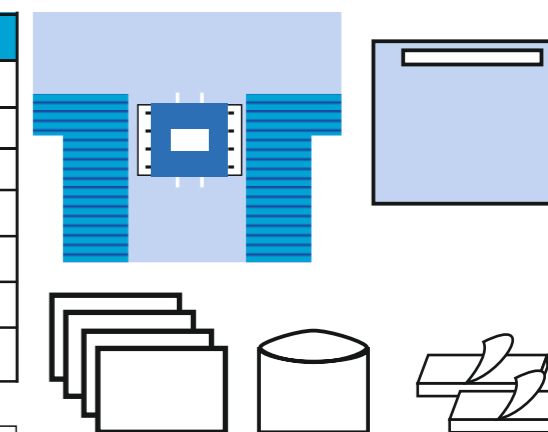

Product Use	General Surgical - 02
Product Code	DL01

Description	QTY	Size
Drape With Opening	1	160*300
Camera Cover	1	80*100
Trolley(Back Table Cover)	1	150*190
Mayo Stand Cover	1	80*145
Double Face Tape	2	10*50
Medical Towels	4	30*33
PE Bag	1	30*40

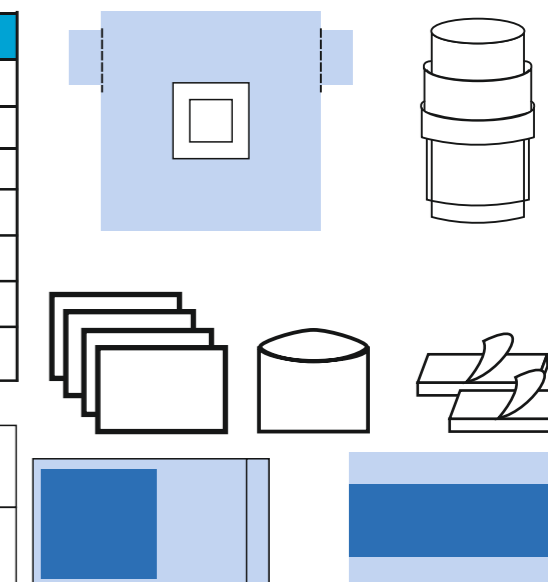

Product Use	General Surgical - 03
Product Code	DL01

Description	QTY	Size
Drape With Opening Size (25*30) Cm	1	160*300
Self-Adhesive Drape	4	80*100
Trolley (Back Table Cover)	1	150*190
Mayo Stand Cover	1	80*145
Medical Towels	4	30*33
Standard Surgical Gown	3	XL
PE Bag	1	30*40

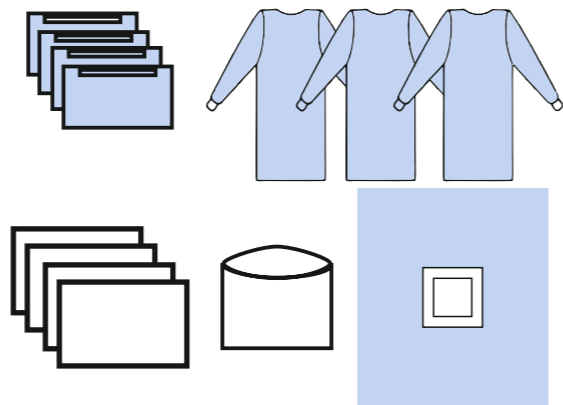

Product Use	General Surgical 8/6 B
Product Code	DL01



Description	QTY	Size
Drape With Opening Size (25*30) Cm	1	160*300
Self-Adhesive Drape	6	80*100
Trolley (Back Table Cover)	1	150*190
Mayo Stand Cover	1	80*145
Medical Towels	4	30*33
PE Bag	2	30*40

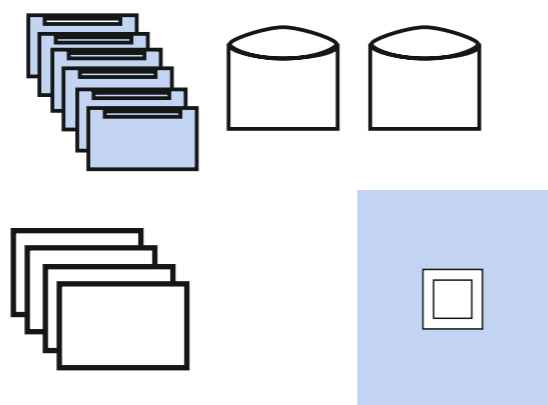

Product Use	General Surgical 8/6 C
Product Code	DL01



Description	QTY	Size
Ophthalmic drape with two pouches open size 10 CM	1	120*150
Trolley(Back Table Cover)	1	80*90
Mayo Cover	1	80*145
Bed Cover	1	120*150
Armchair Cover	2	40*40
Utility Drape	4	80*90
Surgical Gown	2	XL

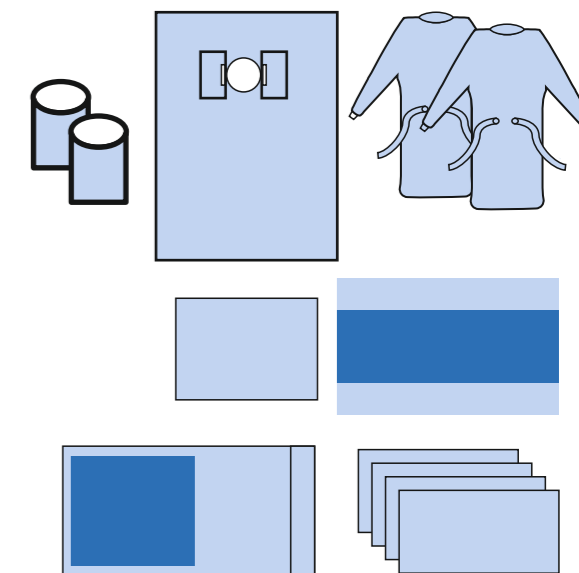

Product Use	Ophthalmic - 03
Product Code	D002

Description	QTY	Size
Ophthalmic drape with two pouches open size 10 CM	1	120*150
Trolley(Back Table Cover)	2	150*190
Armchair Cover	2	40*40
Surgical Gown	2	XL
PE Bag	2	10*50

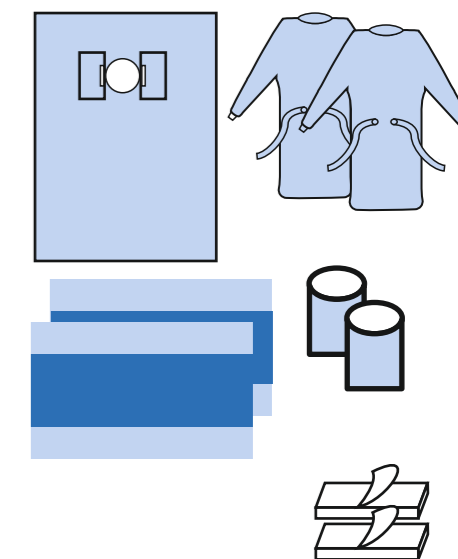

Product Use	Ophthalmic - 04
Product Code	D002

Description	QTY	Size
Trolley (Back Table cover)	1	150*190
C-Section Drape with Adhesive	1	160*300
Baby Drape	1	80*80
Medical Towels	1	30*33
Mayo Stand Cover	1	80*145

Product Use	Cesarean - 01
Product Code	DL01

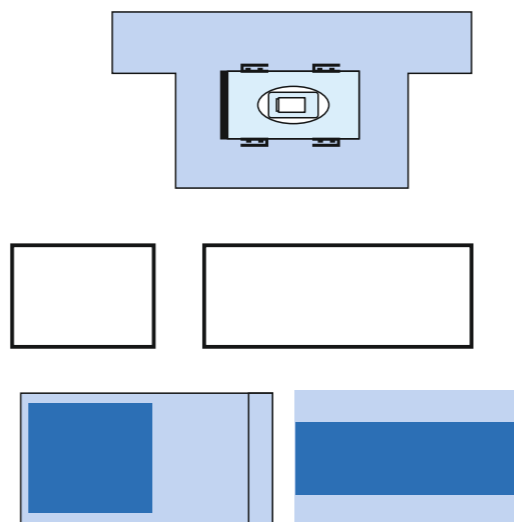

Description	QTY	Size
Trolley (Back Table cover)	1	150*190
C-Section Drape with Adhesive	1	160*300
Baby Drape	1	80*80
Medical Towels	2	30*33
Double Face Tape	1	10*50

Product Use	Cesarean - 02
Product Code	DL01

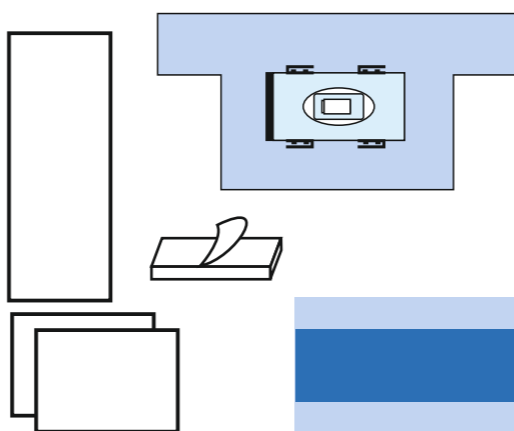

Description	QTY	Size
Trolley (Back Table cover)	1	150*190
C-Section Drape with Adhesive	1	160*300
Baby Drape	1	75*80
Medical Towels	1	30*33

Product Use	Cesarean - 03
Product Code	DL01

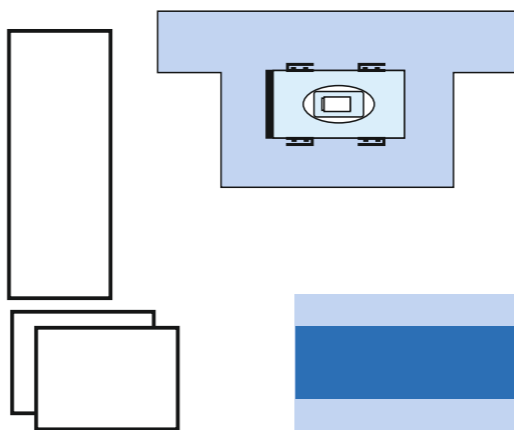

Description	QTY	Size
Drape With Opening Size (25*30) Cm	1	160*300
Self-Adhesive Drape	4	80*100
Trolley (Back Table Cover)	1	150*190
Mayo Stand Cover	1	80*145
PE Bag	1	30*40
Utility Drape	2	75*80

Product Use	Reinforced General Surgical
Product Code	DL01

Description	QTY	Size
Drape With Opening Size (25*30) Cm	1	160*300
Self-Adhesive Drape	4	80*100
Trolley (Back Table Cover)	1	150*190
Mayo Stand Cover	1	80*145
Medical Towels	4	30*33
PE Bag	1	30*40

Product Use	General Surgical 8/6
Product Code	DL01

Description	QTY	Size
Drape With Opening Size (25*30) Cm	1	160*300
Self-Adhesive Drape	4	80*100
Trolley (Back Table Cover)	1	150*190
Mayo Stand Cover	1	80*145
Medical Towels	4	30*33
Standard Surgical Gown	1	XL
PE Bag	1	30*40

Product Use	General Surgical 8/6 A
Product Code	DL01

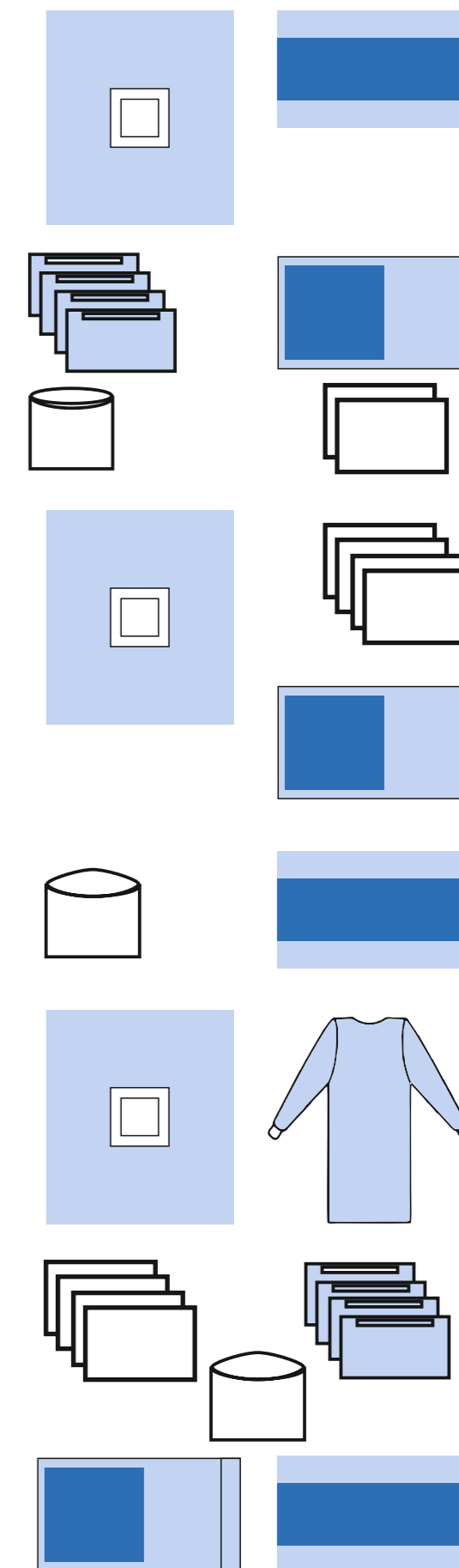

Description	QTY	Size
Back Table Cover	1	150*190
Self-Adhesive Drape	1	160*300
Double Face Tape	1	10*50
Medical Towels	2	30*33

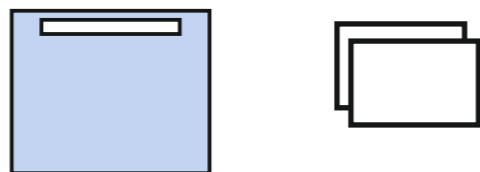

Product Use	Universal Surgical - 07
Product Code	DL01

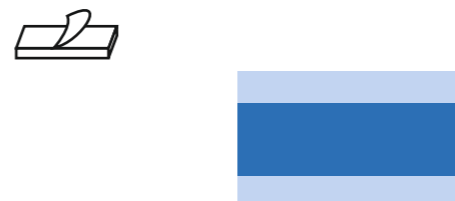

Description	QTY	Size
Trolley (Back Table Cover)	1	150*190
U Split Drape (Drape With Opening)	1	160*300
Self Adhesive Drape	1	80*100
Double Face Tape	1	10*50
Medical Towels	2	30*33

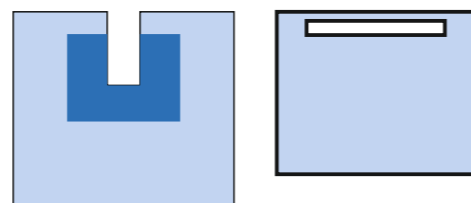

Product Use	Universal Surgical - 08
Product Code	DL01

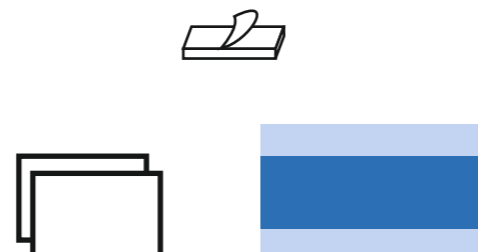

Description	QTY	Size
Trolley (Back Table cover)	1	150*190
Leggings	2	80*140
Self-Adhesive drape	2	80*100

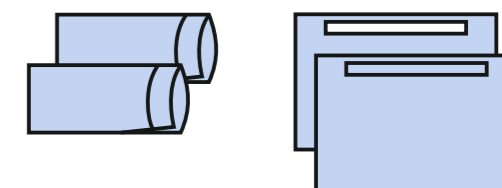

Product Use	Delivery - 01
Product Code	DL01



Description	QTY	Size
Trolley (Back Table cover)	1	150*190
Medical Towels	4	30*33
Leggings	3	75*140
Self-Adhesive Drape	2	80*100
C.V.P Drape With Reinforced holl (15)cm	1	80*80

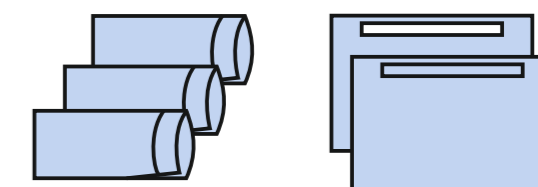

Product Use	Delivery - 02
Product Code	DL01



Description	QTY	Size
Trolley (Back Table cover)	1	150*190
Medical Towels	4	30*33
Leggings	2	80*140
Self-Adhesive Drape	2	80*100
Baby Drape	1	80*80

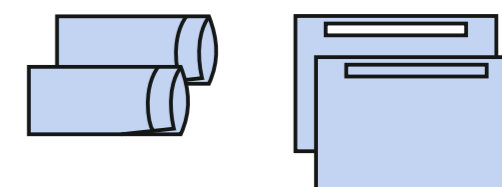

Product Use	Delivery - 03
Product Code	DL01



Description	QTY	Size
Drape With Opening Size(20*30) cm	1	160*180
Self-Adhesive Drape	5	80*100
Mayo Stand Cover	1	80*145
Separate Drape Without Adhesive	1	80*100
Surgical Gown	3	L

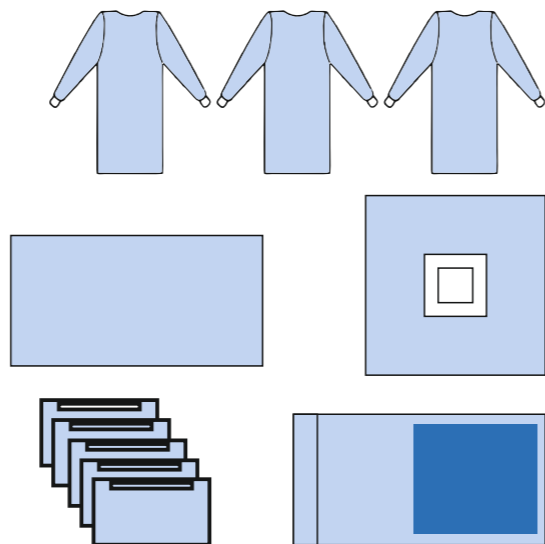

Product Use	Universal Surgical - 01
Product Code	DL01

Description	QTY	Size
Self-Adhesive drape	2	80*100
Head drape	1	80*100
Feet drape	1	80*100
Trolley (Back Table cover)	1	150*190
Medical Towels	2	30*33

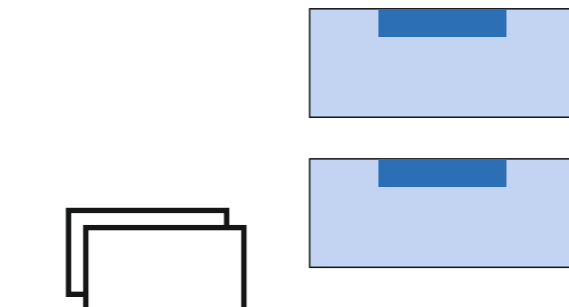

Product Use	Universal Surgical - 02
Product Code	DL01

Description	QTY	Size
Self-Adhesive drape	2	80*100
Head drape	1	30*30
Feet drape	1	80*100
Trolley (Back Table cover)	1	150*190
Mayo Stand Cover	1	80*145
Double Face Tape	1	10*50
Medical Towels	1	30*33

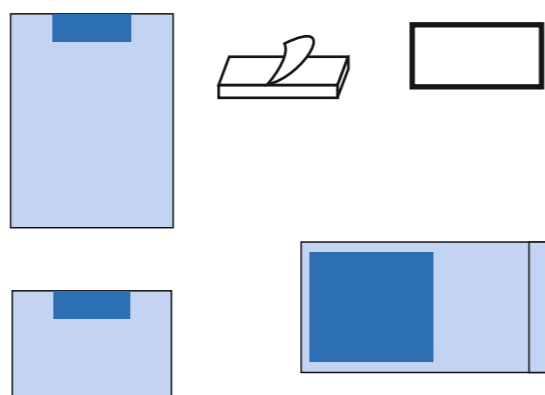

Product Use	Universal Surgical - 03
Product Code	DL01



Description	QTY	Size
Self-Adhesive drape	2	80*100
Head drape	1	80*100
Feet drape	1	80*100
Trolley (Back Table cover)	1	150*190
Mayo Stand Cover	1	80*145
Double Face Tape	2	10*50
Medical Towels	4	30*33
PE Bag	1	30*40



Product Use	Universal Surgical - 04
Product Code	DL01

Description	QTY	Size
Adhesive Drape Sheet	1	150*250
Adhesive Drape Sheet	1	150*200
Adhesive Drape Sheet	2	80*100
Trolley(Back Table Cover)	1	150*190
Mayo Stand Cover	1	80*145
Medical Towels	2	30*33
Double Face Tape	2	10*50

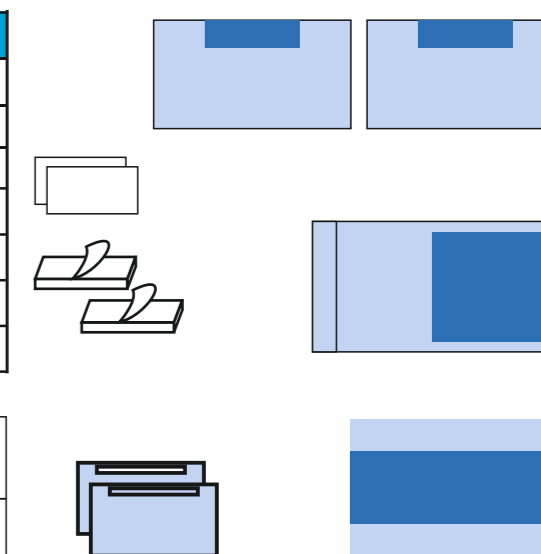

Product Use	Universal Surgical - 05
Product Code	DL01

Description	QTY	Size
Self-Adhesive drape	4	80*100
Trolley (Back Table cover)	1	150*190
Medical Towels	4	30*33

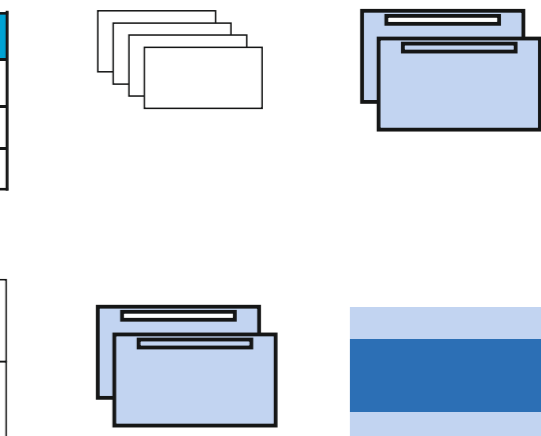

Product Use	Universal Surgical - 06
Product Code	DL01